

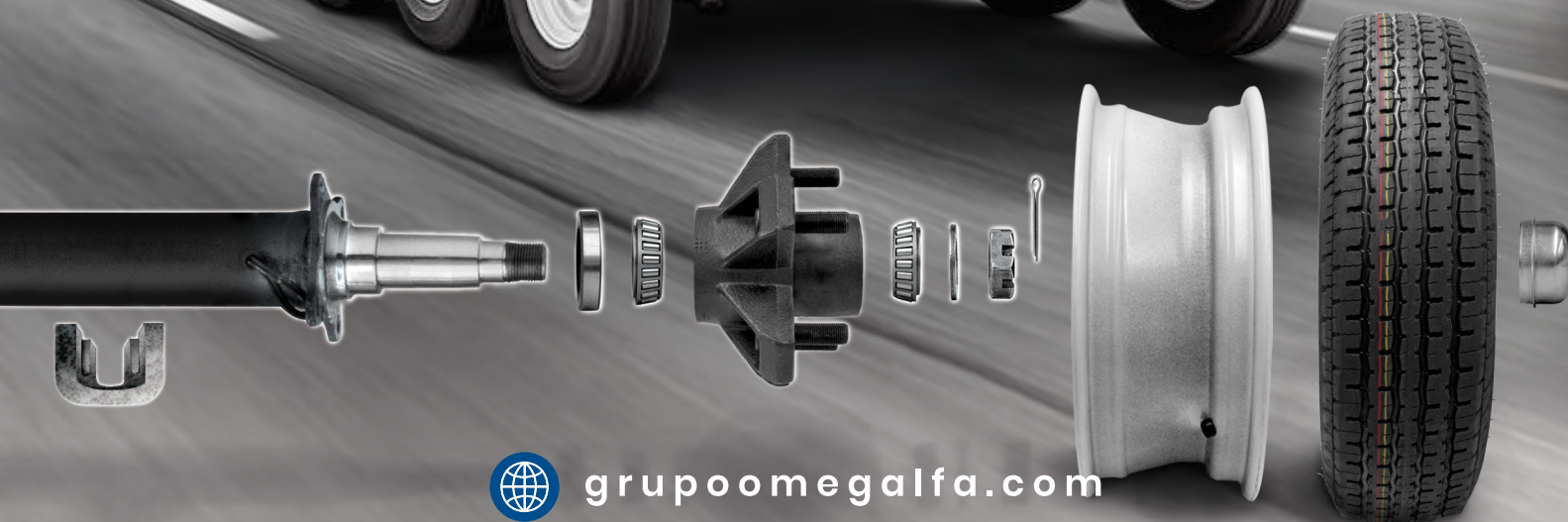

# PARTES PARA REMOLQUES





# OMEGALFA®

Grupo Omegalfa es una empresa mexicana creada con el propósito de proveer con eficiencia y profesionalismo aquellos productos que los fabricantes de remolques, los usuarios de andenes o de equipos industriales requieren. Estamos comprometidos con el éxito de nuestros clientes. Buscamos la mejora continua ofreciendo el mejor servicio, soluciones innovadoras y precios competitivos en un marco de seguridad, desarrollo y cuidado del medio ambiente.

Trabajamos con marcas nacionales e internacionales. Proporcionamos atención a toda la República Mexicana y Centroamérica. Tenemos material en existencia, atención en piso, además, los mejores tiempos de entrega sobre pedidos especiales.

## Partes para Remolques

En la división de Partes para Remolques, manejamos un amplio surtido en partes y accesorios de alta calidad y de marcas reconocidas como Dexter, Buyers, Fulton, Atwood, Tekonsha, Curt, Task Master, Bulldog, Ram, Alaska Hitch, Lombra y Kinedyne. Usted podrá encontrar ejes, gatos, llantas, rines, conectores, luces, masas, tambores, espigas, guardafangos, muelles, tirones, jalones y mucho más. Abarcamos diversos giros: industrial, deportivo, recreativo, agrícola y ganadero.

## El Equipo de Grupo Omegalfa

### Marcas principales:



<b>SUSPENSIÓN</b>	
Ejes	5
Espigas	7
Masas	8
Tambores	9
Kits de Sujeción para Ejes	10
Muelles	12

<b>ARRASTRE</b>	
Bolas de Arrastre	13
Tirones	14
Tirones Hidráulicos	17
Ganchos y Donas	18
Quinta Rueda y Cuello de Ganso	19
Jalones para Vehículos	20
Cadenas y Herrajes	21
Accesorios para Bolas	22

<b>FRENOS</b>	
Platos Eléctricos	24
Platos Hidráulicos	26
Controles de Frenos Eléctricos	27
Líneas Hidráulicas	28

<b>LUCES Y CONECTORES</b>	
Luces	24
Soportes para Luces	26
Conectores	27
Convertidores y Cables	28

<b>GUARDAFANGOS</b>	
Guardafangos Sencillos	39
Guardafangos Tándem y Triple	40

<b>GATOS</b>	
Gatos Fijos	41
Gatos Giratorios	44

<b>MARINOS</b>	
Rodillos y sus Soportes	46
Topes de Hule	49
Winches Galvanizados	50

### RINES Y LLANTAS

Rin y Llanta Montada _____	51
Llanta Sola _____	53
Rin Solo _____	54

### REFACCIONES

Refacciones para Masas y Tambores _____	56
Refacciones para Frenos Eléctricos _____	61
Refacciones para Frenos Hidráulicos _____	62
Refacciones para Ejes y Espigas _____	63
Refacciones para Sujeción y Suspensión _____	65
Refacciones para Gatos _____	67
Refacciones para Tirones _____	69

### MISCELÁNEOS Y ACCESORIOS

Misceláneos y Accesorios _____	70
Remolques para Caballos _____	74

CAPACIDADES 2,000 / 3,500 / 6,000 Y 7,000 LB

PARA ESPIGA BT16



0-20XX-1

MODELO	DESCRIPCIÓN	LONGITUD
0-2048-1	Eje recto 2,000 LB	49"
0-2060-1	Eje recto 2,000 LB	61"
0-2072-1	Eje recto 2,000 LB	73"
0-2084-1	Eje recto 2,000 LB	85"
0-2088-1	Eje recto 2,000 LB	89"

PARA ESPIGA 84



0-35XX-1

MODELO	DESCRIPCIÓN	LONGITUD
0-3560-1	Eje recto 3,500 LB	61"
0-3572-1	Eje recto 3,500 LB	73"
0-3584-1	Eje recto 3,500 LB	85"
0-3588-1	Eje recto 3,500 LB	89"
0-3591-1	Eje recto 3,500 LB	92"
0-3595-1	Eje recto 3,500 LB	95"

PARA ESPIGA 42



0-60XX-1

MODELO	DESCRIPCIÓN	LONGITUD
0-6074-1	Eje recto 6,000 LB	75"
0-6084-1	Eje recto 6,000 LB	85"
0-6088-1	Eje recto 6,000 LB	89"
0-6091-1	Eje recto 6,000 LB	92"
0-6095-1	Eje recto 6,000 LB	95"

PARA ESPIGA 42



0-70XX-1

MODELO	DESCRIPCIÓN	LONGITUD
0-7074-1	Eje recto 7,000 LB	75"
0-7084-1	Eje recto 7,000 LB	85"
0-7088-1	Eje recto 7,000 LB	89"
0-7095-1	Eje recto 7,000 LB	95"

EJES A DESNIVEL 3,500 / 6,000 Y 7,000 LB



0-35XX-1



0-60XXD-1

0-70XXD-1

MODELO	DESCRIPCIÓN	LONGITUD
0-3574D-1	Eje desnivel 3,500 LB	75"
0-3584D-1	Eje desnivel 3,500 LB	85"
0-3588D-1	Eje desnivel 3,500 LB	89"
0-3595D-1	Eje desnivel 3,500 LB	95"

MODELO	DESCRIPCIÓN	LONGITUD
0-6074D-1	Eje desnivel 6,000 LB	75"
0-6084D-1	Eje desnivel 6,000 LB	85"
0-6088D-1	Eje desnivel 6,000 LB	89"
0-6095D-1	Eje desnivel 6,000 LB	95"
0-7074D-1	Eje desnivel 7,000 LB	75"
0-7084D-1	Eje desnivel 7,000 LB	85"
0-7088D-1	Eje desnivel 7,000 LB	89"
0-7095D-1	Eje desnivel 7,000 LB	95"

EJES DE TORSIÓN (PAR MITAD)



0-SPE2000-1

MODELO	DESCRIPCIÓN	CAPACIDAD
0-SPE2000-1	Kit mitad izquierda y derecha	2,000 LB
0-SPE3500-1	Kit mitad izquierda y derecha	3,500 LB
0-SPE6000-1	Kit mitad izquierda y derecha	6,000 LB

\*Ejes de torsión Kit dos piezas (derecha-izquierda) 2,000, 3,500 y 6,000 LB.

\*Ejes de torsión una pieza (sobre medida) 2,000, 3,500 y 6,000 LB.

EJES RECTOS 10,000 LB

MODELO	PATRÓN DE BIRLOS	LONGITUD
0-C10074ES-1	Eje 10,000 LB frenos eléc., 8-6.5 c/muelles	74"
0-C10074L8-1	Eje 10,000 LB s/frenos, 8-6.5 c/muelles	74"



0-C10074ES-1

KIT DE EJE RECTO PARA 10,000 LB CONTIENE:  
Asientos, abrazaderas, tambores o masas,  
frenos eléctricos y las muelles.

**ESPIGA BT16**



0-47221-1

**ESPIGA 84**



0-4720-1

**ESPIGA 84 CON PLACA**



0-4720F-1

**ESPIGA 84 DESNIVEL**



0-2156-1

**ESPIGA 42**



0-4721-1

**ESPIGA 42 CON PLACA**



0-4721F-1

**ESPIGA 42 DESNIVEL**



0-2157-1

MODELO	DESCRIPCIÓN	CAPACIDAD POR ESPIGA (1 PIEZA)	CAPACIDAD DE EJE
0-47221-1	Espiga BT16	1,000 LB	2,000 LB

MODELO	DESCRIPCIÓN	CAPACIDAD POR ESPIGA (1 PIEZA)	CAPACIDAD DE EJE
0-4720-1	Espiga 84	1,750 LB	3,500 LB
0-4720F-1	Espiga 84 con placa	1,750 LB	3,500 LB
0-2156-1	Espiga 84 desnivel	1,750 LB	3,500 LB

MODELO	DESCRIPCIÓN	CAPACIDAD POR ESPIGA (1 PIEZA)	CAPACIDAD DE EJE
0-4721-1	Espiga 42	3,500 LB	6,000 y 7,000 LB
0-4721F-1	Espiga 42 con placa	3,500 LB	6,000 y 7,000 LB
0-2157-1	Espiga 42 desnivel	3,500 LB	6,000 y 7,000 LB

\*Todas las espigas incluyen los complementos.

**MASAS PARA ESPIGA BT16**



MODELO	PATRÓN DE BIRLOS	CAPACIDAD P/PAR
0-34822444UC1-1	4 en 4"	2,000 LB
0-34822545UC1-1	5 en 4.5"	2,000 LB



**MASA PARA ESPIGA 84**



MODELO	PATRÓN DE BIRLOS	CAPACIDAD P/PAR
0-84545UC1-1	5 en 4.5"	3,500 LB
0-84550UC1-1	5 en 5"	3,500 LB
0-84555UC1-1	5 en 5.5"	3,500 LB
0-84575UC1-1	5 en 4.75"	3,500 LB
0-84655UC1-1	6 en 5.5"	3,500 LB



**MASA PARA ESPIGA 42**



MODELO	PATRÓN DE BIRLOS	CAPACIDAD P/PAR
0-42655UC1-1	6 en 5.5"	5,200 LB
0-42865UC1-1	8 en 6.5"	6,000 y 7,000 LB



**MASA PARA EJE DE 10,000 LB**



0-10865UC-1

MODELO	PATRÓN DE BIRLOS	CAPACIDAD P/PAR
0-10865UC1-1	8 en 6.5"	10,000 LB



*\* Todas las masas incluyen complementos.*



**TAMBOR PARA ESPIGA BT16**



0-48546UC3-1



MODELO	PATRÓN DE BIRLOS	CAPACIDAD POR PAR
0-48546UC3-1	5 en 4.5"	2,000 LB

**TAMBOR PARA ESPIGA 84**



0-84XXXXXX-1



MODELO	PATRÓN DE BIRLOS	CAPACIDAD POR PAR
0-84546UC3-1	5 en 4.5"	3,500 LB
0-84556UC3-1	5 en 5"	3,500 LB
0-84557UC3-1	5 en 5.5"	3,500 LB
0-84576UC3-1	5 en 4.75"	3,500 LB
0-84656UC3-1	6 en 5.5"	3,500 LB

**TAMBOR PARA ESPIGA 42**



0-42XXXXXX-1



MODELO	PATRÓN DE BIRLOS	CAPACIDAD P/PAR
0-42656UC3-1	6 en 5.5"	6,000 LB
0-42866UC1-1	8 en 6.5"	6,000 y 7,000 LB

**TAMBOR-MASA PARA EJE DE 10,000 LB**



0-98865UC3-1



MODELO	PATRÓN DE BIRLOS	CAPACIDAD P/PAR
0-98865UC3-1	8 en 6.5"	10,000 LB

*\* Todos los tambores incluyen complementos.*

**KIT DE ABRAZADERA CUADRADA**

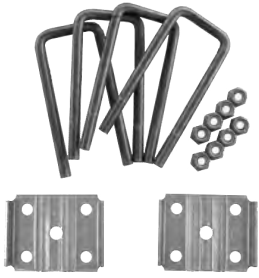

**0-APUBR10C-1**

<i>MODELO</i>	<i>PARA EJE DE</i>
0-APUBR10C-1	2,000 LB
0-APUBR1C-1	3,500 LB

**KIT DE ABRAZADERA REDONDA**

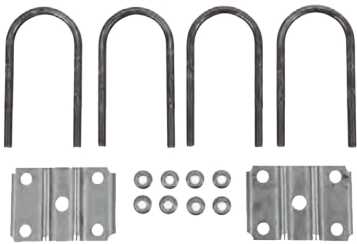

**0-APUBR10-1**

<i>MODELO</i>	<i>PARA EJE DE</i>
0-APUBR10-1	2,000 LB
0-APUBR1-1	3,500 LB
0-APUBR9-1	6,000 Y 7,000 LB
0-APUBR50-1	10,000 LB

**KIT DE SUJECCIÓN SENCILLO PARA EJE DE 2,000 Y 3,500 LB**



**0-APS3SE-1**

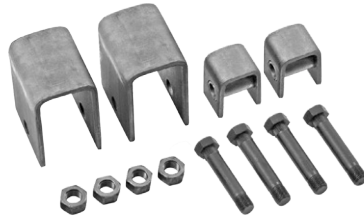

**0-APS5-1**

<i>MODELO</i>	<i>PARA EJE DE</i>
0-APS3SE-1	2,000 LB
0-APS5-1	3,500 LB

**KIT DE SUJECCIÓN TÁNDEM PARA EJE DE 3,500 LB**

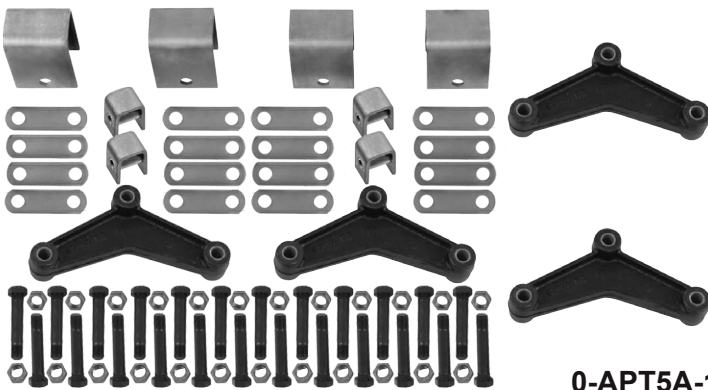

**0-APT5A-1**

<i>MODELO</i>	<i>PARA EJE DE</i>
0-APT5-1	3,500 LB
0-APT5A-1	3,500 LB

**KIT DE DE SUJECIÓN SENCILLO Y TÁNDEM PARA EJES DE 6,000 Y 7,000 LB**

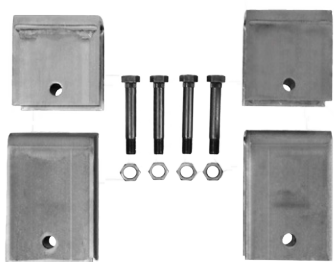

**0-APS6SE-1**

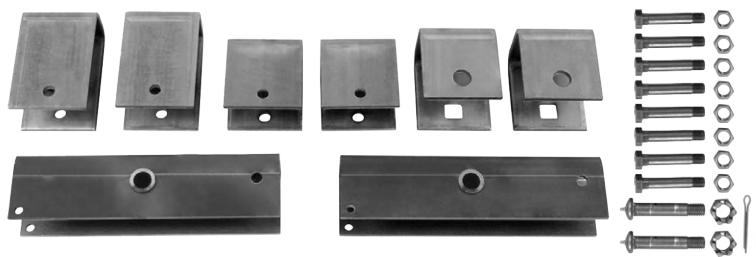

**0-APT6SE-1**

MODELO	PARA EJE DE
0-APS6SE-1	6,000 y 7,000 LB

MODELO	PARA EJE DE
0-APT6SE-1	6,000 y 7,000 LB

**KIT DE SUJECIÓN CON SUJETADOR TRIPLE PARA EJE DE 6,000 Y 7,000 LB**



**0-4113H-1**

MODELO	DESCRIPCIÓN
0-4113H-1	Sujetador triple con balancines.

**KIT DE DE SUJECIÓN SENCILLO Y TÁNDEM PARA EJE DE 10,000 LB**

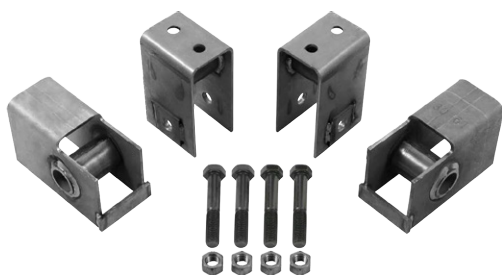

**0-APS1025-1**



**0-HAP256-1**

MODELO	DESCRIPCIÓN
0-APS1025-1	10,000 LB, Sujetador sencillo

MODELO	DESCRIPCIÓN
0-HAP256-1	10,000 LB, Balancines y Percha central

**MUELLE DESLIZABLE  
3 HOJAS**



**MUELLE DESLIZABLE 4 HOJAS  
REFORZADA**



**MUELLE DOBLE OJO 4 HOJAS**



**MUELLE DOBLE OJO 4  
HOJAS REFORZADA**



**MUELLE DESLIZABLE 5 HOJAS**



**MUELLE DESLIZABLE 5 HOJAS**

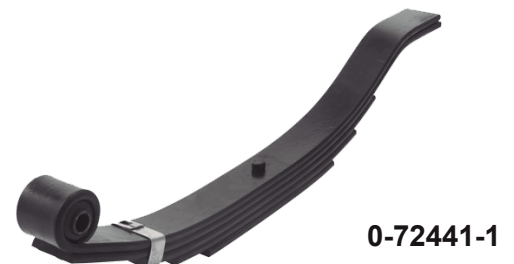

MODELO	ESTILO	HOJAS	ANCHO	LARGO	CAPACIDAD POR PAR
0-WIE3-1	Deslizable	3 hojas	1-3/4"	24"	1,500 LB
0-WIH4-1	Deslizable	4 hojas	1-3/4"	24"	2,000 LB
0-SW4B-1	Doble ojo	4 hojas	1-3/4"	25-1/4"	3,500 LB
0-SW4-1	Doble ojo	4 hojas	1-3/4"	25-1/4"	4,800 LB
0-E226-1	Deslizable	5 hojas	2"	27"	6,000 LB
0-72441-1	Deslizable	5 hojas	2-1/2"	30-1/2"	10,000 LB

**BOLAS CROMADAS DE 1 - 7/8", 2" y 2 - 5/16"**



**KIT BOLA OCULTA DE 2-5/16"**



1-G9000-1

\*Abrazaderas de refacción para Kit bola oculta



\*1-BRB03-1

**BOLAS FORJADAS DE 2" Y 2-5/16"**



1-21HT-1

1-25162HT-1

1-2516114HT-1

**BOLAS DE REPUESTO PARA TIRONES TIPO GANCHO**



\*\*1-RB2000-1

\*\*1-RB2516-1

Refacción Tirón  
1-BPH2000-1

Refacción Tirón  
1-BH82516-1

- Página 18 -

- Página 18 -

MODELO	ESTILO	DIÁMETRO	PERNO	CAPACIDAD
1-17834C-1	Cromada	1-7/8"	3/4x1-5/8"	2,000 LB
1-1781C-1	Cromada	1-7/8"	11x2-1/8"	3,500 LB
1-234C-1	Cromada	2"	3/4x2"	3,500 LB
1-234CXLS-1	Cromada	2"	3/4x3"	3,500 LB
1-21XLS-1	Cromada	2"	1x3"	7,500 LB
1-21C-1	Cromada	2"	1x2"	7,500 LB
1-2516ILS-1	Cromada	2-5/16"	1x2"	7,500 LB
1-3215C-1	Cromada	2"	1-1/4" x 2"	10,000 LB
1-2516114-1	Cromada	2-5/16"	1-1/4" x 2"	15,000 LB
1-G9000-1	Kit bola oculta	2-5/16"	N/A	25,000 LB
1-21HT-1	Forjada	2"	1x2"	7,000 LB
1-25162HT-1	Forjada	2-5/16"	2X3-1/2"	30,000 LB
1-2516114HT-1	Forjada	2-5/16"	1-1/4" x 2"	30,000 LB
**1-RB2000-1	Cromada	2"	1x2-1/4"	12,000 LB
**1-RB2516-1	Cromada	2-5/16"	1x2-1/4"	13,000 LB

\* Los juegos de abrazaderas se solicitan por separado (1-BRB03-1).

\*\* Bolas de repuesto para tirones tipo gancho.

**TIRÓN PARA BOLA 1-78"  
CANAL 2" 2,000 LB**



1-11200-1

**TIRÓN PARA BOLA 1-7/8"  
CANAL 2-1/2" 2,000 LB**



1-11250-1

**TIRÓN PARA BOLA  
1-7/8" CANAL 3" 2,000 LB**



1-3111-1

**TIRÓN PARA BOLA 2"  
CANAL 2" 3,500 LB**



1-22200-1

**TIRÓN PARA BOLA 2"  
CANAL 2" 5,000 LB**



1-80082-1

**TIRÓN PARA BOLA 2"  
CANAL DE 2-1/2" 3,500 LB**



1-22250-1

**TIRÓN PARA BOLA 2"  
CANAL DE 3" 3,500 LB**



1-3104S-1

**TIRÓN PARA BOLA 2"  
CANAL 3" 5,000 LB**



**1-2B4H-1**

**TIRÓN PARA BOLA 2"  
CANAL 3" 7,000 LB**



**1-3B4H-1**

**TIRÓN PARA BOLA 2-5/16"  
CANAL 3" 12,500 LB**



**1-4B4H-1**

**TIRÓN PARA BOLA 2"  
5,000 LB  
TIPO A TROQUELADO**



**1-80071-1**

**TIRÓN PARA BOLA 2"  
5,000 LB  
TIPO A FORJADO**

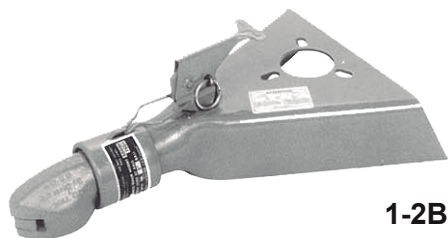

**1-2B8-1**

**TIRÓN PARA BOLA 2"  
7,000 LB  
TIPO A FORJADO**



**1-3B8-1**

**TIRÓN PARA BOLA 2"  
7,000 LB MARCA RAM  
TIPO A FORJADO**



**1-3B8Q-1**

**TIRÓN PARA BOLA 2-5/16"**  
**8,500 LB**  
 TIPO A TROQUELADO



**1-80101-1**

**TIRÓN PARA BOLA 2-5/16"**  
**CANAL TIPO "A" 12,500 LB**



**1-4B8-1**

**TIRÓN PARA BOLA 2-5/16"**  
**CANAL TIPO "A" 12,500 LB RAM**



**1-4B8Q-1**

**TIRÓN PARA BOLA 2-5/16"**  
**CANAL TIPO "A" 15,000 LB**



**1-80132-1**

MODELO	ESTILO	BOLA	CHASIS	CAPACIDAD
1-11200-1	Recto Troquelado	1-7/8"	2"	2,000 LB
1-11250-1	Recto Troquelado	1-7/8"	2-1/2"	2,000 LB
1-3111-1	Recto Troquelado	1-7/8"	3"	2,000 LB
1-22200-1	Recto Troquelado	2"	2"	3,500 LB
1-80082-1	Recto Troquelado	2"	2"	5,000 LB
1-22250-1	Recto Troquelado	2"	2-1/2"	3,500 LB
1-3104S-1	Recto Troquelado	2"	3"	3,500 LB
1-2B4H-1	Recto Forjado	2"	3"	5,000 LB
1-3B4H-1	Recto Forjado	2"	3"	7,000 LB
1-4B4H-1	Recto Forjado	2-5/16"	3"	12,500 LB
1-80071-1	Tipo A Troquelado	2"	A	5,000 LB
1-2B8-1	Tipo A Forjado	2"	A	5,000 LB
1-3B8-1	Tipo A Forjado	2"	A	7,000 LB
1-3B8Q-1	Tipo A Forjado	2"	A	7,000 LB
1-80101-1	Tipo A Troquelado	2-5/16"	A	8,500 LB
1-4B8-1	Tipo A Forjado	2-5/16"	A	12,500 LB
1-4B8Q-1	Tipo A Forjado	2-5/16"	A	12,500 LB
1-80132-1	Tipo A Forjado	2-5/16"	A	15,000 LB



**TIRON BOLA 2" 7,000 LB**

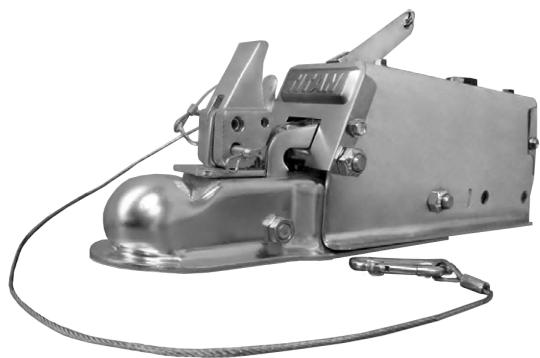

**1-9050299-1**

**TIRON BOLA 2-5/16" 10,000 LB**



**1-15210-1**

**TIRÓN BOLA 2-5/16" 20,000 LB**



**1-16075-1**

**TIRÓN DONA 20,000 LB**



**1-12974-1**

*\* Para líneas hidráulicas ver página 28, Frenos*

MODELO	ESTILO	BOLA	CAPACIDAD
1-9050299-1	Tirón recto	2"	7,000 LB
1-15210-1	Tirón recto	2-5/16"	10,000 LB
1-16075-1	Tirón recto	2-5/16"	20,000 LB
1-12974-1	Tirón recto tipo ojo 3"	N/A	20,000 LB

TIRONES TIPO GANCHO



1-T60AOL-1



1-PH8-1



1-T60AOL8-1



1-PH20-1



1-PH45-1

TIRONES TIPO GANCHO CON BOLA



1-BPH2000-1



1-BH82516-1

MODELO	ESTILO	CAPACIDAD
1-T60AOL-1	Tirón tipo gancho	10,000 LB
1-PH8-1	Tirón tipo gancho	16,000 LB
1-T60AOL8-1	Tirón tipo gancho	30,000 LB
1-PH20-1	Tirón tipo gancho	40,000 LB
1-PH45-1	Tirón tipo gancho	90,000 LB
1-BPH2000-1	Tirón tipo gancho c/bola de 2"	16,000 LB
1-BH82516-1	Tirón tipo gancho c/bola de 2-5/16"	16,000 LB

TIRONES TIPO GANCHO CON RECIBIDOR



1-RM5P

TIRONES TIPO GANCHO CON RECIBIDOR Y BOLA



1-RM6200-1



1-RM62516-1

\* Bolas de repuesto en página 13.

MODELO	ESTILO	CAPACIDAD
1-RM5P	Tirón tipo gancho con receptor	10,000 LB
1-RM6200-1	Tirón tipo gancho c/bola de 2"	12,000 LB
1-RM62516-1	Tirón tipo gancho c/bola de 2-5/16"	12,000 LB

TIRONES TIPO DONA



1-LW10-1



1-16137-1



1-12503-1



1-125015-1



1-BDB1385-1

MODELO	ESTILO	CAPACIDAD
1-LW10-1	Tirón tipo dona 2-1/2" diámetro interior	10,000 LB
1-16137-1	Tirón tipo dona 3" diámetro interior	12,000 LB
1-12503-1	Tirón tipo dona 2-1/2" diámetro interior	15,000 LB
1-125015-1	Tirón tipo dona 2-1/2" diámetro interior	42,000 LB
1-BDB1385-1	Tirón tipo dona 3" diámetro interior	60,000 LB

## QUINTA RUEDA



1-FW0001-1

MODELO	ESTILO	PARA PERNO	CAPACIDAD
1-FW0001-1	Quinta rueda	2"	32,000 LB

## PERNO REY FORJADO



1-KP20038440-1

MODELO	ESTILO	TIPO	PERNO
1-KP20038440-1	Perno rey forjado c/base 3/8"	Soldable	2"

## TIRÓN CUELLO DE GANSO PARA BOLA 2-5/16"



1-GG2516A-1

MODELO	ESTILO	BOLA	CAPACIDAD
1-GG2516A-1	Tirón cuello de ganso	2-5/16"	20,000 LB

\* Se recomienda utilizar con el Kit de bola oculta 1-G900-1. Pag.13

**MARCAS DISPONIBLES:** DODGE, FORD, CHEVROLET, NISSAN, TOYOTA, HONDA **TIPO DE VEHÍCULO:** PICK UP, SUV, MINIVAN, CHASIS CABINA, CAMIÓN **INCLUYE:** KIT DE INSTALACIÓN

**DISPONIBLE CON ACCESORIOS:** SOPORTE DE BOLA, BOLA, CADENA DE SEGURIDAD, PERNO

*\* Para cotización, proporcionar modelo, marca y año del vehículo.*



## CADENA DE 3/16"



1-3235-1

## CADENA DE 1/4"



1-3237-1

## CADENA DE 3/8"



1-B03835SC-1

## GANCHO TIPO "S"



1-7445-1

## ESLABÓN 5/16"



1-7503205-1

## ESLABÓN 3/8"



1-Q38-1

\*Medidas nominales. Podrían variar  $\pm 10\%$ .

MODELO	ESTILO	LARGO C/GANCHO	CAPACIDAD
1-3235-1	Cadena 3/16" c/ganchos de seguridad	50-3/4"	2,000 LB
1-3237-1	Cadena 1/4" c/ganchos de seguridad	49-1/2"	5,000 LB
1-B03835SC-1	Cadena 3/8" c/ganchos de seguridad	38-3/4"	26,000 LB
1-7445-1	Gancho tipo "S" p/cadena 1-3235-1 y 1-3237-1	N/A	N/A
1-7503205-1	Eslabón 5/16"	N/A	N/A
1-Q38-1	Eslabón 3/8"	N/A	N/A

**SOPORTE RECTO PARA BOLA  
(LENGÜETA)**



1-95-1

**SOPORTE "Z" CORTO PARA BOLA  
(LENGÜETA)**



1-HLB2-1

**SOPORTE TIPO "Z" LARGO PARA BOLA**



1-HLB4-1

**SOPORTE TIPO "Z" PARA BOLA**



1-HLB6-1

**SOPORTE TIPO "Z" SÓLIDO**



1-1803056-1

**BUJE REDUCTOR PARA SOPORTE**



1-HBB1-1

**CLIP FORMA R**



8-21R-1

MODELO	ESTILO	BAJADA	PERNO
1-95-1	Soporte recto galvanizado para receptor 1-1/4"	N/A	3/4"
1-HLB2-1	Soporte tipo "Z" para bola	5 cm	1"
1-HLB4-1	Soporte tipo "Z" para bola	10 cm	1"
1-HLB6-1	Soporte tipo "Z" para bola	15 cm	1"
1-1803056-1	Soporte tipo "Z" sólido para bola	10 cm	1-1/4"
1-HBB1-1	Buje reductor para soporte de 1" a 3/4"	N/A	1" a 3/4"
8-21R-1	Clip forma R	N/A	24 y 25

## PERNO CLIP 1/2"



1-25-1

## PERNO CLIP 5/8"

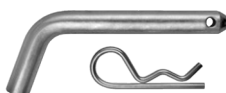

1-243-1

## PERNO CLIP 5/8"



1-24-1

## PERNO CON LLAVE



1-1480DAT1

## CANDADO AJUSTABLE



1-2847DAT-1

## SOPORTE TRIBOLA



1-1802200-1

## TUBO RECIBIDOR CON BASE



1-SBH2-1

## SOPORTE CORTO PARA TIRÓN



1-PM87-1

## SOPORTE LARGO PARA TIRÓN



1-PM812-1

MODELO	ESTILO	BAJADA	PERNO
1-25-1	Perno c/clip 1/2" para soporte "Z"	N/A	1/2"
1-243-1	Perno c/clip 5/8" para soporte "Z"	N/A	5/8"
1-24-1	Perno c/clip 5/8" para soporte "Z"	N/A	5/8"
1-1480DAT-1	Perno c/llave para soporte "Z"	N/A	5/8"
1-2847DAT-1	Candado ajustable para tirones 1-22200-1 y 1-80071-1	N/A	N/A
1-1802200-1	Soporte tribola 1-7/8", 2" y 2-5/16"	N/A	N/A
1-SBH2-1	Tubo receptor con base	N/A	N/A
1-PM87-1	Soporte corto para tirón gancho T60 Y PH	N/A	N/A
1-PM812-1	Soporte largo para tirón gancho T60 Y PH	N/A	N/A

PLATO ELÉCTRICO IZQUIERDO 7-1/4"



2-2347LH-1

PLATO ELÉCTRICO DERECHO 7-1/4"



2-2348RH-1

PLATO ELÉCTRICO IZQUIERDO 10"



2-2326LH-1

PLATO ELÉCTRICO DERECHO 10"



2-2327RH-1

PLATO ELÉCTRICO IZQUIERDO 12"



2-23105LH-1

PLATO ELÉCTRICO DERECHO 12"



2-23106RH-1

MODELO	DESCRIPCIÓN	DIÁMETRO	CAPACIDAD DEL EJE
2-2347LH-1	Plato de freno eléctrico izquierdo	7-1/4"	2,000 LB
2-2348RH-1	Plato de freno eléctrico derecho	7-1/4"	2,000 LB
2-2326LH-1	Plato de freno eléctrico izquierdo	10"	3,500 LB
2-2327RH-1	Plato de freno eléctrico derecho	10"	3,500 LB
2-23105LH-1	Plato de freno eléctrico izquierdo	12"	6,000 y 7,000 LB
2-23106RH-1	Plato de freno eléctrico derecho	12"	6,000 y 7,000 LB



PLATO ELÉCTRICO IZQUIERDO 12-1/4"



2-23450LH-1

PLATO ELÉCTRICO DERECHO 12-1/4"



2-23451RH-1

MODELO	DESCRIPCIÓN	DIÁMETRO	CAPACIDAD DEL EJE
2-23450LH-1	Plato de freno eléctrico izquierdo, doble rodado	12-1/4"	10,000 LB
2-23451RH-1	Plato de freno eléctrico derecho, doble rodado	12-1/4"	10,000 LB

PLATO HIDRÁULICO IZQUIERDO 7-1/4"



2-23398LH-1

PLATO HIDRÁULICO DERECHO 7-1/4"



2-23399RH-1

PLATO HIDRÁULICO IZQUIERDO 10"



2-23312LH-1

PLATO HIDRÁULICO DERECHO 10"



2-23313RH-1

PLATO HIDRÁULICO IZQUIERDO 12"



2-23324LH-1

PLATO HIDRÁULICO DERECHO 12"



2-23325RH-1

MODELO	DESCRIPCIÓN	DIÁMETRO	CAPACIDAD DEL EJE
2-23398LH-1	Plato de freno hidráulico izquierdo	7-1/4"	2,000 LB
2-23399RH-1	Plato de freno hidráulico derecho	7-1/4"	2,000 LB
2-23312LH-1	Plato de freno hidráulico izquierdo	10"	3,500 LB
2-23313RH-1	Plato de freno hidráulico derecho	10"	3,500 LB
2-23324LH-1	Plato de freno hidráulico izquierdo	12"	6,000 y 7,000 LB
2-23325RH-1	Plato de freno hidráulico derecho	12"	6,000 y 7,000 LB

**KIT FRENOS DE EMERGENCIA  
TEKONSHA**



**2-2028-1**

**CONTROL TEKONSHA  
VOYAGER**



**2-9030-1**

**CONTROL CURT DISCOVERY**



**2-90301-1**

**CONTROL CURT VENTURER**



**2-90302-1**

**INTERRUPTOR PARA CONTROL**



**2-RA230-1**

MODELO	DESCRIPCIÓN
2-2028-1	Juego de frenos de emergencia para frenos eléctricos.
2-9030-1	Control eléctrico de 2 a 4 frenos, modelo VOYAGER, tamaño compacto.
2-90301-1	Control eléctrico de 2 a 4 frenos, modelo DISCOVERY con pantalla digital, frenado suave.
2-90302-1	Control de 2 a 4 frenos, modelo VENTURER con pantalla, frenado suave.
2-RA230-1	Protector para interrupciones de frenado en control de freno eléctrico.

### LÍNEA SENCILLA PARA UN EJE

2-9504-1



### LÍNEA TÁNDEM PARA DOS EJES

2-9505-1

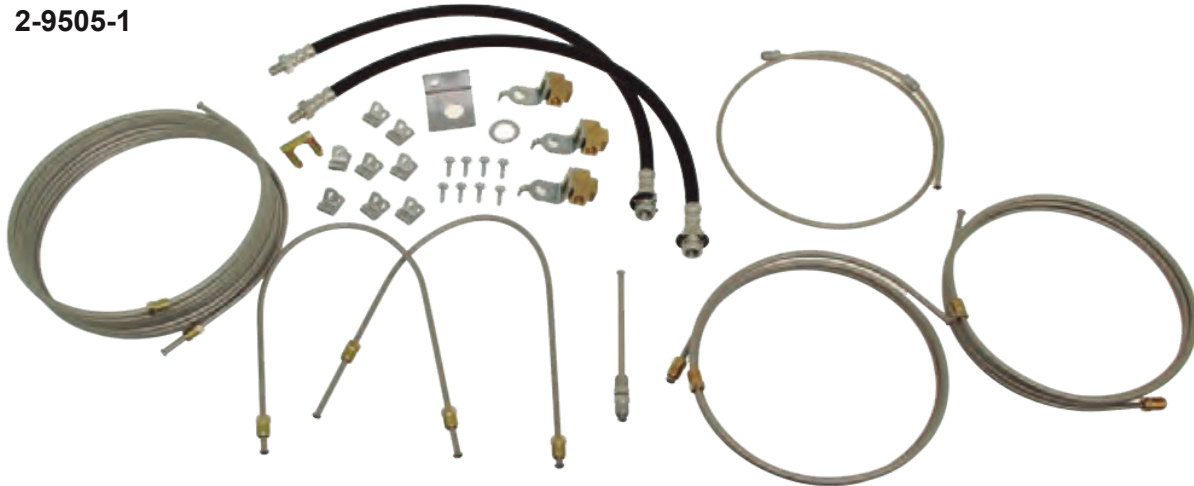

MODELO	DESCRIPCIÓN
2-9504-1	Línea hidráulica para eje sencillo
2-9505-1	Línea hidráulica para eje tándem

**LUZ ÁMBAR LATERAL Y REFLECTOR**

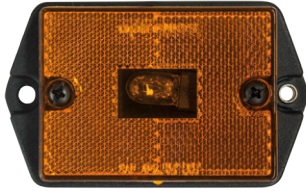

**3-115A-1**

**LUZ ROJA LATERAL Y REFLECTOR**



**3-115R-1**

**LUZ ÁMBAR LATERAL CON BASE METÁLICA**



**3-119AT-1**

**LUZ LED ÁMBAR LATERAL CON BASE METÁLICA**



**3-119RT-1**

**LUZ ROJA LATERAL CON BASE METÁLICA**



**3-119ALED-1**

**LUZ LED ROJA LATERAL CON BASE METÁLICA**



**3-119RLED-1**

<b>MODELO</b>	<b>DESCRIPCIÓN</b>	<b>COLOR</b>
3-115A-1	Luz y reflector lateral con base de plástico	Ámbar
3-115R-1	Luz y reflector lateral con base de plástico	Rojo
3-119AT-1	Luz lateral con base metálica	Ámbar
3-119RT-1	Luz lateral con base metálica	Rojo
3-119ALED-1	Luz LED lateral con base metálica	Ámbar
3-119RLED-1	Luz LED lateral con protector y base metálica	Rojo

## LUZ ÁMBAR PARA CUARTOS



3-150A-1

## LUZ ROJA PARA CUARTOS



3-150R-1

## LUZ ÁMBAR SELLADA DOBLE FOCO



3-152A-59

## LUZ ROJA SELLADA DOBLE FOCO



3-152R-59

## LUZ ÁMBAR RECTANGULAR DOBLE ÓPTICO



3-2635A-59

## LUZ ROJA RECTANGULAR DOBLE ÓPTICO



3-2635R-59

MODELO	DESCRIPCIÓN	COLOR
3-150A-1	Luz para cuartos, forma rectangular	Ámbar
3-150R-1	Luz para cuartos, forma rectangular	Rojo
3-152A-59	Luz sellada doble foco, con base negra	Ámbar
3-152R-59	Luz sellada doble foco, con base negra	Rojo
3-2635A-59	Luz rectangular doble óptico	Ámbar
3-2635R-59	Luz rectangular doble óptico	Rojo

**LUZ RECTANGULAR IZQUIERDA**



**3-3504-1**

**LUZ RECTANGULAR DERECHA**



**3-3554-1**

**LUZ 6" ÁMBAR FORMA OVAL SELLADA**



**3-421KA-59**

**LUZ 6" BLANCA FORMA OVAL SELLADA**



**3-421KB-59**

**LUZ ROJA FORMA OVAL SELLADA**



**3-421KR-59**

**LUZ ÁMBAR 4" SELLADA**



**3-426KA-59**

<b>MODELO</b>	<b>DESCRIPCIÓN</b>	<b>COLOR</b>
3-3504-1	Luz rectangular derecha, a prueba de agua	Rojo
3-3554-1	Luz rectangular izquierda, a prueba de agua	Rojo
3-421KA-59	Luz 6" forma oval, sellada, con hule y conector	Ámbar
3-421KB-59	Luz 6" forma oval, sellada, con hule y conector	Blanco
3-421KR-59	Luz 6" forma oval, sellada, con hule y conector	Rojo
3-426KA-59	Luz 4" sellada, con hule y conector	Ámbar

**LUZ BLANCA 4" SELLADA**



**3-426KB-59**

**LUZ ROJA 4" SELLADA**



**3-426KR-59**

**LUZ ÁMBAR 10 LED's  
OVAL SELLADA**



**3-421KALED-59**

**LUZ BLANCA DE 10 LED's  
OVAL SELLADA**



**3-421KBLED-59**

**LUZ ROJA DE 10 LED's  
OVAL SELLADA**



**3-421KRLED-59**

**LUZ ÁMBAR DE 10 LED's 4"  
CON HULE Y CONECTOR**



**3-426KALED-59**

<b>MODELO</b>	<b>DESCRIPCIÓN</b>	<b>COLOR</b>
3-426KB-59	Luz 4" sellada, con hule y conector	Blanco
3-426KR-59	Luz 4" sellada, con hule y conector	Rojo
3-421KALED-59	Luz de 10 LED's, 6" forma oval, sellada, con hule y conector	Ámbar
3-421KBLED-59	Luz de 10 LED's, 6" forma oval, sellada, con hule y conector	Blanco
3-421KRLED-59	Luz de 10 LED's, 6" forma oval, con hule y conector	Rojo
3-426KALED-59	Luz de 10 LED's, 4" con hule y conector	Ámbar



**LUZ BLANCA DE 10 LEDS 4" CON HULE Y CONECTOR**



**3-426KBLED-59**

**LUZ ROJA DE 10 LEDS 4" CON HULE Y CONECTOR**



**3-426KRLED-59**

**LUZ CURVITA ÁMBAR 5 LED's**



**3-733A-59**

**LUZ CURVITA ÁMBAR 5 LED's MICA TRANSPARENTE**



**3-734A-59**

**LUZ CURVITA ROJA 5 LED'S**



**3-733R-59**

**LUZ CURVITA ROJA 5 LED's MICA TRANSPARENTE**



**3-734R-59**

<b>MODELO</b>	<b>DESCRIPCIÓN</b>	<b>COLOR</b>
3-426KBLED-59	Luz de 10 LED's, 4" con hule y conector	Blanco
3-426KRLED-59	Luz de 10 LED's, 4" con hule y conector	Rojo
3-733A-59	Luz curvita 5 LED's	Ámbar
3-734A-59	Luz curvita 5 LED's, mica transparente	Ámbar
3-733R-59	Luz curvita 5 LED's	Rojo
3-734R-59	Luz curvita 5 LED's, mica transparente	Rojo

**BARRA DE 3 LUCES  
DE 6 CM SELLADA**



**3-M1503R-1**

**BARRA DE 3 LUCES LED  
DE 6 CM SELLADA**



**3-M1503RLED-1**

**TIRA REFLEJANTE  
ROJO CON BLANCO**

De venta únicamente en  
tiras de 30 cm.



**3-CT150W12-1**

**LUZ TRASERA DERECHA**



**3-440R-1**

**LUZ TRASERA IZQUIERDA**



**3-440L-1**

**JUEGO DE LUCES TRASERAS**



**3-K540-1**

<b>MODELO</b>	<b>DESCRIPCIÓN</b>	<b>COLOR</b>
3-M1503R-1	Barra de 3 luces, 6 cm, sellada	Rojo
3-M1503RLED-1	Barra de 3 luces, 6 cm, sellada	Rojo
3-CT150W12-1	Tira reflejante. Largo 30 cm, ancho 5 cm. Color rojo-blanco.	-
3-440R-1	Luz trasera, lado derecho, forma cuadrada	Rojo
3-440L-1	Luz trasera, lado izquierdo, forma cuadrada	Rojo
3-K540-1	Juego de luces traseras con conector	Rojo / Ámbar

**SOPORTE DE LÁMINA NEGRA  
PARA LUZ OVAL DE 6"**



**3-42109-59**

**SOPORTE DE LÁMINA NEGRA  
PARA LUZ REDONDA DE 4"**



**3-42609-59**

**SOPORTE GALVANIZADO PARA  
PLACA DE TRÁNSITO**



**3-42809-1**

**SOPORTE PARA LUZ  
3-440L-1 Y 3-440R-1**



**3-51009-1**

<b>MODELO</b>	<b>DESCRIPCIÓN</b>
3-42109-59	Soporte de lámina negra para luz oval de 6"
3-42609-59	Soporte de lámina negra para luz de 4"
3-42809-1	Soporte galvanizado para placa de tránsito
3-51009-1	Soporte para luz 3-440L-1 y 3-440R-1

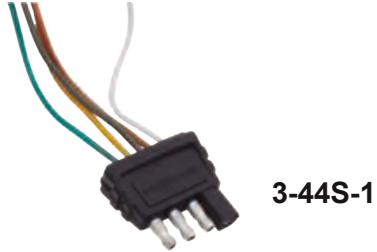
**CONECTOR 3 VÍAS SELLADO****CONECTOR 2 VÍAS SELLADO****CONECTOR PLANO PARA VEHÍCULO****CONECTOR PLANO PARA REMOLQUE****CONECTOR REDONDO PARA REMOLQUE****CONECTOR REDONDO PARA VEHÍCULO**

<b>MODELO</b>	<b>DESCRIPCIÓN</b>	<b>NO. DE HILOS</b>
3-2750-59	Conector de 3 vías sellado	N/A
3-2751-59	Conector de 2 vías sellado	N/A
3-44P-1	Conector plano para remolque	4
3-44S-1	Conector plano para vehículo	4
3-5410R-1	Conector redondo para remolque	4
3-5410V-1	Conector redondo para vehículo	4

**CONECTOR REDONDO  
PARA REMOLQUE**



3-11604-1

**CONECTOR REDONDO  
PARA VEHÍCULO**



3-11609-1

**CONECTOR REDONDO  
PARA REMOLQUE**



3-11700-1

**CONECTOR REDONDO  
PARA VEHÍCULO**



3-11720-1

**CONECTOR REDONDO  
PARA REMOLQUE**



3-12706-1

**CONECTOR REDONDO  
PARA VEHÍCULO**



3-12707-1

**BASE PARA CONECTORES  
3-11609-1 Y 3-11410-1**



3-11617-1

**BASE PARA CONECTOR  
3-12707-1**

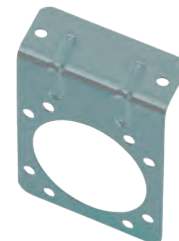

3-12701-1

MODELO	DESCRIPCIÓN	NO. DE HILOS
3-11604-1	Conector redondo para remolque	6
3-11609-1	Conector redondo para vehículo	6
3-11700-1	Conector redondo para remolque	7
3-11720-1	Conector redondo para vehículo	7
3-12706-1	Conector redondo para remolque	7
3-12707-1	Conector redondo para vehículo	7
3-11617-1	Base para conectores 3-11609-1	-
3-12701-1	Base para conector 3-12707-1	-

**CONVERTIDOR DE 6 A 4 HILOS**



**3-TCA624-1**

**CONVERTIDOR DE 7 A 4 HILOS**



**3-TCA724-1**

**CONVERTIDOR DE 7 A 6 HILOS**



**3-TCA726-1**

**CONVERTIDOR DE 5 A 4 HILOS**



**3-TLC101-1**

**CABLE PLANO**



**\*3-4WPD-1**

**CABLE PLANO FORRADO PARA FRENOS**



**\*3-5221-1**

**CABLE REDONDO**

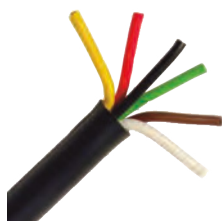

**\*3-6WRD-1**

MODELO	DESCRIPCIÓN
3-TCA624-1	Convertidor de 6 a 4 hilos
3-TCA724-1	Convertidor de 7 a 4 hilos
3-TCA726-1	Convertidor de 7 a 6 hilos
3-TLC101-1	Convertidor de 5 a 4 hilos

**\*Venta por metro.**

MODELO	DESCRIPCIÓN	NO. DE HILOS	CALIBRE
*3-4WPD-1	Cable plano	4	16
*3-5221-1	Cable plano forrado para frenos	2	14
*3-6WRD-1	Cable redondo	6	14

PARA RIN 13"  
CON CEJA



4-2137-1

PARA RIN 13"  
SIN CEJA



4-2306-1

PARA RIN 14" Y 15"



4-2105-1

PARA RIN 15"  
ANCHO



4-2108-1

PARA RIN 16"  
ANCHO



4-2106-1

MODELO	DESCRIPCIÓN	MEDIDAS	PARA RIN
4-2137-1	Guardafango sencillo, con ceja	20 cm x 69 cm	13"
4-2306-1	Guardafango sencillo, sin ceja	20 cm x 69 cm	13"
4-2105-1	Guardafango sencillo	23 cm x 81 cm	14" y 15"
4-2108-1	Guardafango sencillo ancho	27 cm x 82 cm	15"
4-2106-1	Guardafango sencillo ancho	27 cm x 91 cm	16"

PARA RIN 13" Y 14"



4-2111-1

PARA RIN 14" Y 15"



4-2112-1

PARA RIN 15" Y 16"



4-2114-1

PARA RIN 14" y 15"



4-2122-1

PARA RIN 14" Y 15"



4-2122T-1

PARA RIN 15" Y 16"



4-2124T-1

PARA RIN 15" Y 16"



4-2124-1

PARA RIN 15" Y 16"



4-2141-1

MODELO	DESCRIPCIÓN	MEDIDAS	PARA RIN
4-2111-1	Guardafango tándem delgado	23 cm x 168 cm	13" y 14"
4-2112-1	Guardafango tándem delgado	23 cm x 183 cm	14" y 15"
4-2114-1	Guardafango tándem ancho	27 cm x 183 cm	15" y 16"
4-2122-1	Guardafango tándem, con gota	23 cm x 183 cm	14" y 15"
4-2124-1	Guardafango tándem, con gota	27 cm x 183 cm	15" y 16"
4-2122T-1	Guardafango tándem antiderrapante, con gota	23 cm x 183 cm	14" y 15"
4-2124T-1	Guardafango tándem antiderrapante, con gota	27 cm x 183 cm	15" y 16"
4-2141-1	Guardafango triple, con gota	23 cm x 270 cm	15" y 16"



**ESTABILIZADOR  
FIJO-ATWOOD**  
Para soldar o atornillar



5-3315-1

**ESTABILIZADOR  
FIJO-ATWOOD**  
Para soldar o atornillar



5-C3315-1

**GATO FIJO MANIVELA  
SUPERIOR-ATWOOD**  
Fijación tipo "A"



5-80401-1

**GATO FIJO MANIVELA  
SUPERIO-RAM**  
Fijación tipo "A"



5-80401Q-1

**GATO FIJO MANIVELA  
LATERAL-ATWOOD**  
Fijación tipo "A"



5-81041-1

**GATO FIJO MANIVELA  
SUPERIOR-RAM**  
Fijación tipo "A"



5-80402Q-1

**GATO FIJO MANIVELA  
SUPERIOR-ATWOOD**  
Fijación tipo "A"



5-80402-1

**GATO FIJO MANIVELA  
SUPERIOR-BULLDOG**  
Para soldar



5-190500-1

MODELO	DESCRIPCIÓN	MARCA	CARRERA	CAPACIDAD
<i>USO LIGERO</i>				
5-3315-1	Gato estabilizador fijo, barra incluida	Atwood	8"	1,000 lb / 454 kg
5-C3315-1	Gato estabilizador fijo, barra no incluida	Atwood	8"	1,000 lb / 454 kg
5-80401-1	Gato fijo sin soporte, manivela superior	Atwood	14 ½"	2,000 lb / 907 kg
5-80401Q-1	Gato fijo sin soporte, manivela superior	Ram	15 ½"	2,000 lb / 907 kg
5-81041-1	Gato fijo sin soporte, manivela lateral	Atwood	16 ½"	2,000 lb / 907 kg
5-80402Q-1	Gato fijo sin soporte, manivela superior	Ram	15 ½"	3,000 lb / 1,360 kg
5-80402-1	Gato fijo sin soporte, manivela superior	Atwood	15 ¼"	5,000 lb / 2,268 kg
5-190500-1	Gato fijo con soporte, manivela superior	Bulldog	31 ¼"	5,000 lb / 2,268 kg

**GATO FIJO MANIVELA  
LATERAL-BULLDOG**  
*Para soldar*



**5-190510-1**

**GATO FIJO MANIVELA  
LATERAL-RAM**  
*Para soldar*



**5-190510Q-1**

**GATO FIJO MANIVELA  
SUPERIOR-RAM**  
*Para soldar*



**5-190500Q-1**

**GATO FIJO MANIVELA  
SUPERIOR-BULLDOG**  
*Para soldar*



**5-182304-1**

**GATO FIJO MANIVELA  
SUPERIOR-RAM**  
*Para soldar*



**5-182304Q-1**

MODELO	DESCRIPCIÓN	MARCA	CARRERA	CAPACIDAD
<i>USO LIGERO</i>				
5-190510-1	Gato fijo con soporte, manivela lateral	Bulldog	31 ¼"	5,000 lb / 2,267 kg
5-190510Q-1	Gato fijo con soporte, manivela lateral	Ram	31 ½"	7,000 lb / 3,175 kg
5-190500Q-1	Gato fijo con soporte, manivela superior	Ram	28"	8,000 lb / 3,629 kg
<i>USO MEDIO</i>				
5-182304-1	Gato fijo con soporte, manivela superior	Bulldog	34"	12,000 lb / 5,444 kg
5-182304Q-1	Gato fijo con soporte, manivela superior	Ram	34"	12,000 lb / 5,444 kg

**CUELLO DE GANSO  
MANIVELA  
LATERAL BULLDOG**  
*Para soldar*



**5-C182400-1**  
\*No incluye manivela

**CUELLO DE GANSO  
MANIVELA  
LATERAL RAM**  
*Para soldar*



**5-182400Q-1**  
\*Incluye manivela

**GATO FIJO MANIVELA  
LATERAL DERECHA-RAM**  
*Para soldar*

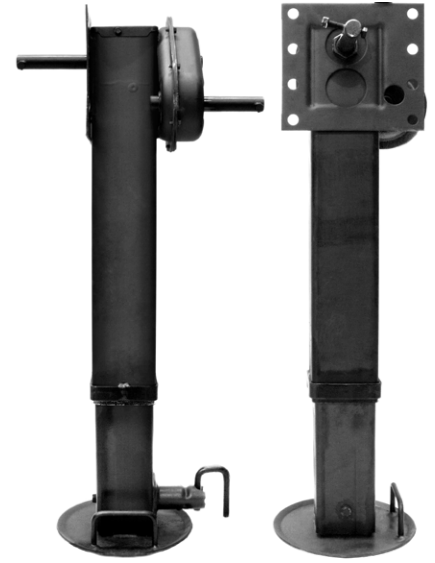

**5-48000Q-1**  
\*No incluye manivela

**MANIVELA PARA  
GATO CON GANCHO**



**5-C015181-1**

**BARRA  
ESTABILIZADORA**  
*Para estabilizador 3315*



**5-CBAR3315-1**

MODELO	DESCRIPCIÓN	MARCA	CARRERA	CAPACIDAD
<b>USO MEDIO</b>				
5-C182400-1	Gato cuello de ganso, manivela no incluida	Bulldog	31"	10,000lb/4,536kg
5-182400Q-1	Gato cuello de ganso, manivela incluida	Ram	30"	10,000lb/4,536kg
<b>USO RUDO</b>				
5-48000Q-1	Gato fijo lateral derecho, manivela no incluida	Ram	29 1/4"	25,000 lb / 11,340 kg
<b>ACCESORIOS</b>				
5-C015181-1	Manivela con gancho. Para gatos 5C182400-1 y 5-48000-1	-	-	-
5-CBAR3315-1	Barra estabilizadora para gato 5-C3315-1	-	-	-

**GATO MANIVELA SUPERIOR-BULLDOG**

*Fijación con placa*



**5-151401-1**

**GATO MANIVELA SUPERIOR-RAM**

*Fijación con placa*



**5-151401Q-1**

**GATO MANIVELA SUPERIOR-BULLDOG**

*Fijación con placa*



**5-151421-1**

**GATO MANIVELA SUPERIOR-RAM**

*Fijación con placa*



**5-151421Q-1**

**GATO MANIVELA LATERAL-BULLDOG**

*Fijación con cilindro*



**5-158109-1**

**GATO MANIVELA LATERAL-RAM**

*Fijación con cilindro*



**5-158109Q-1**

**GATO MANIVELA LATERAL-RAM**

*Fijación con cilindro*



**5-178201Q-1**

MODELO	DESCRIPCIÓN	MARCA	CARRERA	CAPACIDAD
<b>USO LIGERO</b>				
5-151401-1	Gato giratorio con soporte, manivela superior	Bulldog	11 ½"	2,000 lb / 907 kg
5-151401Q-1	Gato giratorio con soporte, manivela superior	Ram	12"	2,000 lb / 907 kg
5-151421-1	Gato giratorio con soporte, manivela superior	Bulldog	18 ½"	2,000 lb / 907 kg
5-151421Q-1	Gato giratorio con soporte, manivela superior	Ram	16 ¼"	2,000 lb / 907 kg
5-158109-1	Gato giratorio con soporte, manivela lateral	Bulldog	11"	2,000 lb / 907 kg
5-158109Q-1	Gato giratorio con soporte, manivela lateral	Ram	12 ¼"	2,000 lb / 907 kg
5-178201Q-1	Gato giratorio con soporte, manivela lateral	Ram	15 ¾"	3,000 lb / 1,360 kg

**GATO MANIVELA SUPERIOR-RAM**

*Fijación con cilindro*



5-8247215-1

**GATO MANIVELA LATERAL-BULLDOG**

*Fijación con cilindro*



5-178201-1

**GATO MANIVELA SUPERIOR-RAM**

*Fijación con cilindro*



5-8247210-1

**GATO MANIVELA LATERAL-FULTON**

*Marino*  
*Fijación con placa.*



5-5754-1

**GATO MANIVELA LATERAL-RAM**

*Marino*  
*Fijación con placa.*



5-5754Q-1

**GATO MANIVELA LATERAL-FULTON**

*Marino*  
*Fijación con placa.*



5-TDJ125-1

**GATO MANIVELA LATERAL-RAM**

*Marino*  
*Fijación con placa.*



5-TDJ125Q-1

MODELO	DESCRIPCIÓN	MARCA	CARRERA	CAPACIDAD
<i>USO LIGERO</i>				
5-8247215-1	Gato giratorio con soporte, manivela superior	Ram	16 ¼"	5,000 lb / 2,268 kg
5-178201-1	Gato giratorio con soporte, manivela lateral	Bulldog	11 ¾"	5,000 lb / 2,268 kg
5-8247210-1	Gato giratorio con soporte, manivela superior	Ram	16 ¼"	5,000 lb / 2,268 kg
5-5754-1	Gato giratorio con llanta, manivela lateral	Fulton	10 ½ "	1,200 lb / 544 kg
5-5754Q-1	Gato giratorio con llanta, manivela lateral	Ram	11 ¼"	1,200 lb / 544 kg
5-TDJ125-1	Gato giratorio con llantas,manivela lateral	Fulton	11¼ "	1,500 lb / 680 kg
5-TDJ125Q-1	Gato giratorio con llantas, manivela lateral	Ram	11 ¼"	1,500 lb / 680 kg

RODILLO DE HULE 4"



6-8501N-1

RODILLO DE HULE 8"



6-8504N-1

RODILLO DE HULE 10"



6-8500-1

RODILLO DE HULE 10"



6-8500N-1

RODILLO DE HULE 12"



6-8502-1

RODILLO DE HULE 12"



6-8502N-1

MODELO	DESCRIPCIÓN	MEDIDAS
6-8501N-1	Rodillo de hule para soporte de lancha hule negro	4"
6-8504N-1	Rodillo de hule para soporte de lancha hule negro	8"
6-85000-1	Rodillo de hule para soporte de lancha hule crudo	10"
6-8500N-1	Rodillo de hule para soporte de lancha hule negro	10"
6-8502-1	Rodillo de hule para soporte de lancha hule crudo	12"
6-8502N-1	Rodillo de hule para soporte de lancha hule negro	12"

\*Medidas nominales.

**SOPORTE GALVANIZADO  
PARA RODILLO DE 8"**



**6-RB811G-1**

**SOPORTE GALVANIZADO  
PARA RODILLO DE 10"**



**6-RB109Z-1**

**SOPORTE GALVANIZADO  
PARA RODILLO DE 12"**



**6-RB129Z-1**

**SOPORTE GALVANIZADO  
PARA CAMA JET SKI 10"**



**6-BB1011Z-1**

**SOPORTE GALVANIZADO  
PARA CAMA DE JET SKI 10"**



**6-FCB1011Z-1**

<b>MODELO</b>	<b>DESCRIPCIÓN</b>	<b>MEDIDAS</b>
6-RB811G-1	Soporte galvanizado para rodillo de hule	8"
6-RB109Z-1	Soporte galvanizado para rodillo de hule	10"
6-RB129Z-1	Soporte galvanizado para rodillo de hule	12"
6-BB1011Z-1	Soporte para cama de jet ski galvanizado	10"
6-FCB1011Z-1	Soporte para cama de jet ski galvanizado	10"

**SOPORTE DE ÁNGULO  
PARA TABLA JET SKI**



**6-AB112-1**

**FLECHA PARA SOPORTE  
Y RODILLO DE 8"**



**6-RS58925Z-1**

**FLECHA PARA SOPORTE  
Y RODILLO DE 10"**



**6-RS5811125Z-1**

**FLECHA PARA SOPORTE  
Y RODILLO DE 12"**



**6-RS581325Z-1**

**SEGURO PARA  
FLECHA DE 5/8"**



**6-8505-1**

<b>MODELO</b>	<b>DESCRIPCIÓN</b>	<b>MEDIDAS</b>
6-AB112-1	Soporte de ángulo para tabla de jet ski	-
6-RS58925Z-1	Flecha para soporte y rodillo modelo 6-8504-1	8"
6-RS5811125Z-1	Flecha para soporte y rodillo modelo 6-8500-1	10"
6-RS581325Z-1	Flecha para soporte y rodillo modelo 6-8502-1	12"
6-8505-1	Seguro para flecha de 5/8"	-



**TOPE DE HULE TIPO V  
2" X 2"**



**6-8227-1**

**TOPE DE HULE TIPO V  
3" X 3"**



**6-8228-1**

**TOPE DE HULE TIPO V  
4" X 4"**



**6-8229-1**

<b>MODELO</b>	<b>DESCRIPCIÓN</b>	<b>MEDIDAS</b>
6-8227-1	Tope de hule tipo V	2"x 2"
6-8228-1	Tope de hule tipo V	3"x 3"
6-8229-1	Tope de hule tipo V	4"x 4"

\*Medidas nominales.

**WINCH GALVANIZADO**  
**1,400 LB**

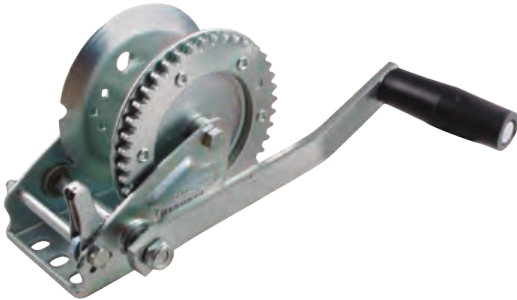

**6-3614-1**

**WINCH GALVANIZADO**  
**1,800 LB**

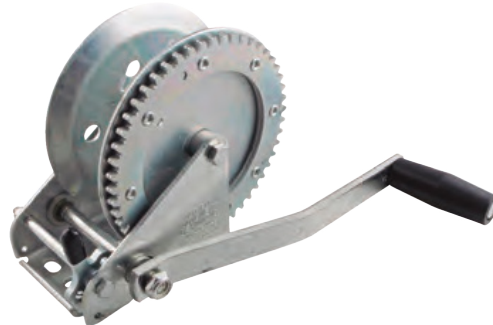

**6-3618-1**

**WINCH GALVANIZADO**  
**2,600 LB**



**6-3626-1**

<b>MODELO</b>	<b>DESCRIPCIÓN</b>	<b>VELOCIDADES</b>	<b>LB</b>	<b>KG</b>
6-3614-1	Winch galvanizado	1	1,400	636
6-3618-1	Winch galvanizado	1	1,800	817
6-3626-1	Winch galvanizado	2	2,600	1,180

**MEDIDA 120/100 - 8"**  
**BIRLOS 5 EN 4.5"**



**7-488TW5-1**

**MEDIDA 144/106 - 8"**  
**BIRLOS 4 EN 4**



**7-570TW4-1**

**MEDIDA 120/100 - 8"**  
**BIRLOS 4 EN 4**



**7-488TW4-1**

**MEDIDA 215/129 - 8"**  
**BIRLOS 4 EN 4**



**7-4804-1**

**MEDIDA 215/129-8"**  
**BIRLOS 5 EN 4.5**



**7-4805-1**

**MEDIDA 144/106 - 8"**  
**BIRLOS 5 EN 4.5**



**7-570TW5-1**

MODELO	DESCRIPCIÓN	PATRÓN DE BIRLOS	MEDIDA COMERCIAL PULG	MM	RIN	CAPACIDAD	PSI MÁX	RANGO CARGA
7-488TW5-1	Llanta Bias con rin 8"	5 en 4.5	8x4.80	120/100	8"	590 LB - 268 KG	60	C
7-570TW4-1	Llanta Bias con rin 8"	4 en 4	8x5.70	144/106	8"	715 LB - 325 KG	50	B
7-488TW4-1	Llanta Bias con rin 8"	4 en 4	8x4.80	120/100	8"	745 LB - 339 KG	90	C
7-4804-1	Llanta Bias con rin 8"	4 en 4	8x18.5	215/129	8"	780 LB - 355 KG	35	B
7-4805-1	Llanta Bias con rin 8"	5 en 4.5	8x18.5	215/129	8"	780 LB - 355 KG	35	B
7-570TW5-1	Llanta Bias con rin 8"	5 en 4.5	8x5.70	144/106	8"	910 LB - 414 KG	75	C

**MEDIDA 121/88 - 12"**  
**BIRLOS 4 EN 4"**



**7-4812TWSPK4B-1**

**MEDIDA 121/76 - 12"**  
**BIRLOS 5 EN 4.5"**



**7-4812TWSPK5B-1**

**MEDIDA 134/109 - 12"**  
**BIRLOS 5 EN 4.5"**



**7-5312TWSPK5B-1**

**MEDIDA 205/133 - 10"**  
**BIRLOS 5 EN 4.5"**



**7-4806-1**

**MEDIDA 205/133 - 10"**  
**BIRLOS 5 EN 4.5"**



**7-4806E-1**

MODELO	DESCRIPCIÓN	PATRÓN DE BIRLOS	MEDIDA COMERCIAL PULG	MM	RIN	CAPACIDAD	PSI MÁX	RANGO CARGA
7-4812TWSPK4B-1	Llanta Bias con rin 12"	4 en 4	12x4.80	121/88	12"	990 LB - 450 KG	90	C
7-4812TWSPK5B-1	Llanta Bias con rin 12"	5 en 4.5	12x4.80	121/76	12"	990 LB - 450 KG	90	C
7-5312TWSPK5B-1	Llanta Bias con rin 12"	5 en 4.5	12x5.30	134/109	12"	1045 LB - 475 KG	90	C
7-4806-1	Llanta Bias con rin 10"	5 en 4.5	10x20.5	205/133	10"	1100 LB - 500 KG	50	C
7-4806E-1	Llanta Bias con rin 10"	5 en 4.5	10x20.5	205/133	10"	1160 LB - 750 KG	90	E

ST175/80D13C LRC 13" BIAS



7-P9300305-1

ST205/75D14C 14" BIAS



7-P519300-1

ST7.00-15 15" BIAS



7-70015-660

ST205/75D15C 15" BIAS



7-P9300313-1

ST225/75R15D 15" RADIAL



7-P9300319-1

ST7.50-16 16" BIAS



7-75016-660

ST235/85R16D 16" RADIAL



7-P5192991-1

ST235/80R16D 16" RADIAL



7-P5192992-1

MODELO	DESCRIPCIÓN	MEDIDA COMERCIAL		RIN	CAPACIDAD	PSI MÁX	RANGO CARGA
		PULG	MM				
7-P9300305-1	Llanta BIAS, ST175/80	7/80	175/140	13"	1,360 LB - 615 KG	50	C
7-P519300-1	Llanta BIAS, ST205/75	8/75	205/153	14"	1,760 LB - 800 KG	50	C
7-75015-660	Llanta BIAS, 7.00/15	7/15	170/153	15"	2,040 LB - 925 KG	60	D
7-P9300313-1	Llanta BIAS, ST205/75	8/75	205/153	15"	2,150 LB - 975 KG	65	D
7-P9300319-1	Llanta RADIAL, ST225/75	8 1/2 /75	225/168	15"	2,540 LB - 1150 KG	65	D
7-75016-660	Llanta BIAS, 7.50/16	7 1/2 /16	190/113	16"	2,755 LB - 1,250 KG	75	E
7-P5192991-1	Llanta RADIAL, ST235/85	9 1/4 /85	235/215	16"	3,640 LB - 1,650 KG	80	E
7-P5192992-1	Llanta RADIAL, ST235/80	9 1/4 /80	235/188	16"	3,420 LB - 1,551 KG	80	E

**RIN DEPORTIVO BLANCO 13"**  
BIRLOS 4 EN 4"



7-171896-1

**RIN DEPORTIVO BLANCO 13"**  
BIRLOS 5 EN 4.5"



7-171897-1

**RIN DEPORTIVO BLANCO 14"**  
BIRLOS 5 EN 4.5"



7-171427-1

**RIN DEPORTIVO BLANCO 15"**  
BIRLOS 5 EN 4.5"



7-171497-1

**RIN DEPORTIVO BLANCO 15"**  
BIRLOS 5 EN 5"



7-171498-1

**RIN DEPORTIVO BLANCO 15"**  
BIRLOS 5 EN 5.5"

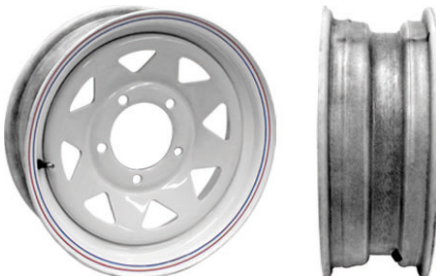

7-171555-1

**RIN DEPORTIVO BLANCO 15"**  
BIRLOS 5 EN 4.75"



7-171575-1

**RIN DEPORTIVO BLANCO 15"**  
BIRLOS 6 EN 5.5"

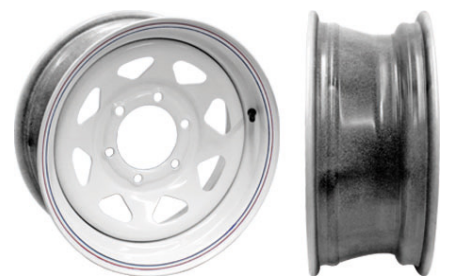

7-4828-1

**RIN DEPORTIVO BLANCO 16"**  
BIRLOS 6 EN 5.5"



**7-4628-1**

**RIN AUSTERO GRIS 16"**  
BIRLOS 8 EN 6.5"



**7-17153-1**

**RIN AUSTERO GRIS 16"**  
**DOBLE RODADO**  
BIRLOS 8 EN 6.5"



**7-4610-1**

**RIN DEPORTIVO BLANCO 16"**  
BIRLOS 8 EN 6.5"



**7-4629-1**

MODELO	DESCRIPCIÓN	TAMAÑO	CAPACIDAD	PATRÓN DE BIRLOS	No. PÁGINA
7-171896-1	Rin deportivo blanco	13"	1,480 LB - 670 KG	4 en 4	No.54
7-171897-1	Rin deportivo blanco	13"	1,480 LB - 670 KG	5 en 4.5	No.54
7-171427-1	Rin deportivo blanco	14"	1,870 LB - 848 KG	5 en 4.5	No.54
7-171497-1	Rin deportivo blanco	15"	1,870 LB - 848 KG	5 en 4.5	No.54
7-171498-1	Rin deportivo blanco	15"	1,870 LB - 848 KG	5 en 5	No.54
7-171555-1	Rin deportivo blanco	15"	1,870 LB - 848 KG	5 en 5.5	No.54
7-171575-1	Rin deportivo blanco	15"	1,870 LB - 848 KG	5 en 4.75	No.54
7-4828-1	Rin deportivo blanco	15"	2,330 LB - 1057 KG	6 en 5.5	No.54
7-4628-1	Rin deportivo blanco	16"	3,200 LB - 1450 KG	6 en 5.5	No.55
7-17153-1	Rin austero gris	16"	3,750 LB - 1700 KG	8 en 6.5	No.55
7-4610-1	Rin austero gris	16"	3,750 LB - 1700 KG	8 en 6.5	No.55
7-4629-1	Rin deportivo blanco	16"	4,080 LB - 1850 KG	8 en 6.5	No.55

**BALERO PARA MASAS\***  
 ESPIGA BT16 1,000 LB C/U  
 ESPIGA 84 1,750 LB C/U



8-L44649-1

**BALERO INTERIOR PARA MASA**  
 ESPIGA 84 1,750 LB C/U



8-L68149-1

**BALERO EXTERIOR PARA MASA 6 BIRLOS**  
 ESPIGA 42 3,500 LB C/U



8-15123-1

**BALERO EXTERIOR PARA MASA 8 BIRLOS**  
 ESPIGA 42 3,500 LB C/U



8-14125A-1

**BALERO INTERIOR PARA MASA 6 Y 8 BIRLOS**  
 ESPIGA 42 3,500 LB C/U



8-25580-1

**BALERO INTERIOR PARA MASA DE 10,000 LB**



8-387A-1

**TASA PARA BALERO 8-L44649-1**



8-L44610-1

**TASA PARA BALERO 8-L68149-1**



8-L68111-1

**TASA PARA BALERO EXTERIOR 8-15123-1**



8-15245-1

MODELO	DESCRIPCIÓN
8-L44649-1	Balero interior/externo para masa de espiga BT16 y exterior para espiga 84.
8-L68149-1	Balero interior para masa de espiga 84.
8-15123-1	Balero exterior para masa de 6 birlos de espiga 42.
8-14125A-1	Balero exterior para masa de 8 birlos de espiga 42.
8-25580-1	Balero interior para masa de 6 y 8 birlos de espiga 42 y exterior para 10,000 LB.
8-387A-1	Balero interior para masa de 10,000 LB.
8-L44610-1	Tasa para balero 8-L44649-1
8-L68111-1	Tasa para balero 8-L68149-1
8-15245-1	Tasa para balero exterior 8-15123-1 para masa y tambor.



**TASA PARA BALERO EXTERIOR 8-14125A-1**



8-L02420-1

**TASA PARA BALERO INTERIOR 8-25580-1**



8-25520-1

**TUERCA 1/2" CÓNICA GALVANIZADA**



8-680-1

**TUERCA CÓNICA 5/8" PARA BIRLO 8-475930-1**



8-475930T-1

**BIRLO PARA MASA Y TAMBOR BT16**



8-4758-1

**BIRLO DE 1/2" X 2"**



8-4759-1

**BIRLO DE 1/2" X 2-1/2"**



8-475925Z-1

**BIRLO DE 5/8" X 3"**



8-475930-1

MODELO	DESCRIPCIÓN
8-L02420-1	Tasa para balero exterior 8-14125A-1.
8-25520-1	Tasa para balero interior 8-25580-1 masas de 5,000 y 6,000 LB.
8-4758-1	Birlo para masa y tambor BT16.
8-680-1	Tuerca cónica de 1/2" galvanizada para birlos
8-475930T-1	Tuerca cónica de 5/8" para birlo 8-475930-1
8-4759-1	Birlo de 1/2" x 2" para masas 84 y 42
8-475925Z-1	Birlo 1/2" x 2-1/2" para tambor 84 y 42
8-475930-1	Birlo de 5/8" x 3" para tambor

**POLVERA PARA  
MASA Y TAMBOR  
ESPIGA BT16**



**8-46749-1**

**POLVERA CON GRASERA  
PARA MASA Y TAMBOR  
ESPIGA 84**



**8-21411-1**

**PROTECTOR PARA  
POLVERA 8-21411-1**



**8-RP100-1**

**POLVERA PARA  
MASA Y TAMBOR  
ESPIGA 42 / 6 BIRLOS**



**8-45895-1**

**POLVERA PARA  
MASA Y TAMBOR  
ESPIGA 42 / 8 BIRLOS**



**8-45896-1**

**POLVERA 3-1/2" DIÁMETRO  
EJE 10,000 LB**



**8-D10C-1**

**POLVERA 3-1/2" DIÁMETRO  
EJE DE 10,000 Y 12,000 LB**



**8-12010-1**

**POLVERA 4" DIÁMETRO  
EJES 10,000 Y 12,000 LB**



**8-12012-1**

**TAPÓN DE HULE  
PARA POLVERAS  
8-12010-1 Y 8-12012-1**



**8-RP200-1**

MODELO	DESCRIPCIÓN
8-46749-1	Polvera para masa y tambor espiga BT16 y 84
8-21411-1	Polvera con grasera para masa y tambor 84
8-RP100-1	Protector para polvera 8-21411-1
8-45895-1	Polvera para masa y tambor 42, 6 birlos
8-45896-1	Polvera para masa y tambor 42, 8 birlos
8-D10C-1	Polvera 3-1/2" para eje de 10,000 LB
8-12010-1	Polvera 3 1/2" para eje de 10,000 y 12,000 LB.
8-12012-1	Polvera 4" de diámetro para ejes de 10,000 y 12,000 LB.
8-RP200-1	Tapón de hule para polveras 8-12010-1 y 8-12012-1

**KIT GRASERA CON  
PROTECTOR**  
MASAS 3,500 LB



**8-HM602-1**

**KIT GRASERA CON  
PROTECTOR**  
MASAS 6,000/7,000 LB  
CON 6 BIRLOS



**8-4764-1**

**KIT GRASERA CON  
PROTECTOR**  
MASAS 6,000/7,000 LB  
CON 8 BIRLOS



**8-4766-1**

**REPUESTO PARA  
GRASERAS**  
8-4764-1 Y 8-4766-1



**8-4764B-1**

**PROTECTOR GRIS  
PARA GRASERAS**  
8-4764-1 Y 8-4766-1

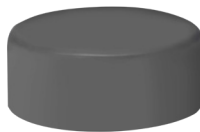

**8-4764P-1**

MODELO	DESCRIPCIÓN
8-HM602-1	Kit grasera con protector para masas 3,500 LB
8-4764-1	Kit grasera con protector para masas con 6 birlos / 6,000 y 7,000 LB
8-4766-1	Kit grasera con protector para masas con 8 birlos / 6,000 y 7,000 LB
8-4764B-1	Protector negro de repuesto para graseras 8-4764-1 y 8-4766-1
8-4764P-1	Protector gris de refuerzo para graseras 8-4764-1 y 8-4766-1

**RONDANA ARAÑA  
PARA TUERCA**



**8-6190-1**

**RONDANA ARAÑA  
1/16" X 2-1/4"**



**8-8750038-1**

**RONDANA PLANA  
1/8" X 2-1/4"**



**8-8750037-1**

<b>MODELO</b>	<b>DESCRIPCIÓN</b>
8-6190-1	Rondana araña para sujetar tuerca y espina
8-8750038-1	Rondana araña 1/16" x 2 1/4"
8-8750037-1	Rondana plana 1/8" x 2 1/4"

**CABLE INTERRUPTOR PARA FRENO DE EMERGENCIA**



**8-2010-1**

**CABLE INTERRUPTOR PARA FRENO DE EMERGENCIA**



**8-20225-1**

**CLIP FORMA "R" PERNO 24 Y 25**

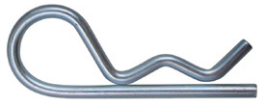

**8-21R-1**

**CLIP SUJETADOR MAGNETO 10,000 LB**



**8-2750-1**

**CLIP SUJETADOR MAGNETO 10" Y 12"**



**8-40813-1**

**MAGNETO PARA PLATO DE 10"**



**8-BP0110-1**

**MAGNETO PARA PLATO DE 12"**



**8-BP0112-1**

**MAGNETO PARA PLATO 10,000 LB**

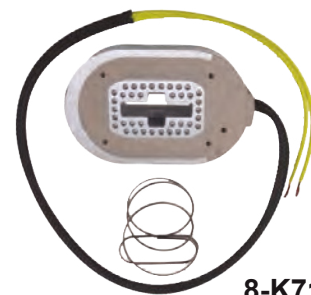

**8-K71376-1**

MODELO	DESCRIPCIÓN
8-2010-1	Cable interruptor para freno de emergencia
8-20225-1	Cable interruptor para freno de emergencia
8-21R-1	Clip en forma de "R" para pernos 24 y 25
8-2750-1	Clip sujetador para magneto, de 10,000 LB
8-40813-1	Clip sujetador de magneto 10" y 12"
8-BP0110-1	Magneto ovalado para plato de 10"
8-BP0112-1	Magneto ovalado para plato de 12"
8-K71376-1	Magneto ovalado para plato de 10,000 LB.

**CILINDRO PLATO HIDRÁULICO  
IZQUIERDO**



**8-BP17020-1**

**CILINDRO PLATO HIDRÁULICO  
DERECHO**



**8-BP17030-1**

<b>MODELO</b>	<b>DESCRIPCIÓN</b>	<b>DIAMETRO</b>
8-BP17020-1	Cilindro para plato hidráulico izquierdo	10" y 12"
8-BP17030-1	Cilindro para plato hidráulico derecho	10" y 12"

**SELLO PARA  
ESPIGA BT16**  
2,000 LB



8-109-1

**SELLO PARA  
ESPIGA 84**  
3,500 LB



8-58846-1

**SELLO PARA  
ESPIGA 42**  
6,000 Y 7,000 LB



8-42385-1

**SELLO PARA EJE**  
10,000 LB



8-10511-1

**ASIENTO PARA EJE**  
2,000 LB

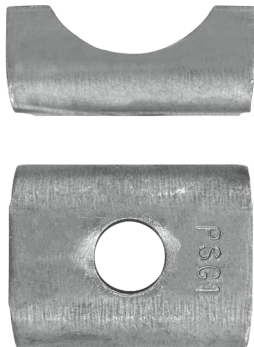

8-349-1

**ASIENTO PARA EJE**  
3,500 LB



8-343-1

**ASIENTO PARA EJE**  
6,000 y 7,000 LB



8-342-1

MODELO	DESCRIPCIÓN
8-109-1	Sello para espiga BT16 y eje 2,000 BL
8-58846-1	Sello para espiga 84 y eje 3,500 LB
8-42385-1	Sello para espiga 42 y eje 6,000 y 7,000 LB
8-10511-1	Sello para eje de 10,000 LB
8-349-1	Asiento para eje de 2,000 LB
8-343-1	Asiento para eje de 3,500 LB
8-342-1	Asiento para eje de 6,000 y 7,000 LB

**COLUMPIO PARA SUSPENSIÓN**



8-41012-1

**TUERCA PARA EJE**



8-8750007-1

**RONDANA TIPO "O" SIN CHAVETA**



8-93001-1

**RONDANA TIPO "O" PARA ESPIGA**



8-SW1000-1

**RONDANA TIPO "D" PARA EJE**



8-SW1001-1

**TUERCA CASTILLO**



8-165686-1

**CHAVETA DE 1/8" POR 1-1/2"**



8-4755-1

MODELO	DESCRIPCIÓN
8-41012-1	Columpio para suspensión de eje
8-8750007-1	Tuerca para eje
8-93001-1	Rondana en forma "O" para eje sin chaveta
8-SW1000-1	Rondana en forma "O" para espiga BT16/84/42
8-SW1001-1	Rondana tipo "D" para eje
8-165686-1	Tuerca Castillo para espiga BT16/84/42
8-4755-1	Chaveta 1/8" por 1-1/2"



**SUJETADOR TRASERO TIPO C**



8-41044-1

**PERCHA CHICA DELGADA PARA APS5**



8-41013-1

**PERCHA 1-3/4" PARA SUSPENSIÓN**



8-41014-1

**PERCHA 2-3/4" PARA SUSPENSIÓN**



8-41014M-1

**PERCHA GRANDE 4" PARA APT5**



8-41014L-1

**PERCHA ALTA 4" PARA APT5**



8-41014LX-1

**BALANCÍN 12" PARA SUSPENSIÓN**



8-41131-1

**PERCHA DELANTERA 4" PARA EJE**



8-41132H-1

**PERCHA TRASERA 4" PARA EJE**



8-41133H-1

MODELO	DESCRIPCIÓN
8-41044-1	Sujetador trasero tipo C para APS3SE
8-41013-1	Percha chica delgada para APS5
8-41014-1	Percha 1 3/4" para suspensión
8-41014M-1	Percha 2 3/4" para suspensión
8-41014L-1	Percha grande 4" para APT5
8-41014LX-1	Percha alta 4" para APT5
8-41131-1	Balancín 12" para suspensión
8-41132H-1	Percha delantera 4" para eje
8-41133H-1	Percha trasera 4" para eje

**PERCHA CENTRAL  
PARA EJE**



8-41134H-1

**TORNILLO TEMPLADO  
9/16" X 3"**



8-41137-1

**TORNILLO TEMPLADO  
9/16" X 3-1/2"**



8-41137L-1

**TUERCA 9/16" PARA  
TORNILLO 8-4113X-1**



8-41016-1

**BUJE PARA BALANCÍN  
Y MUELLE**



8-4370-1

**BALANCÍN PARA APT5**



8-A2252CB-1

**TORNILLO CENTRAL  
PARA APT6SE**



8-4114-1

**TUERCA CASTILLO 3/4"  
PARA TORNILLO CENTRAL**



8-6113-1

MODELO	DESCRIPCIÓN
8-41134H-1	Percha central para eje
8-41137-1	Tornillo templado 9/16" x 3"
8-41137L-1	Tornillo templado 9/16" x 3-1/2" de largo
8-41016-1	Tuerca 9/16" para tornillo 8-4113X-1
8-4370-1	Buje para balancín y muelle
8-A2252CB-1	Balancín 9" para APT5
8-4114-1	Tornillo central para APT6SE
8-6113-1	Tuerca castillo 3/4" para tornillo central 8-4114-1

TAPA PARA GATO



8-015500-1

ARO SUJETADOR PARA GATO



8-015904-1

MANIVELA PARA GATOS



8-018917-1

PLACA SUJECIÓN PARA GATO



8-115909-1

PERNO PARA GATOS

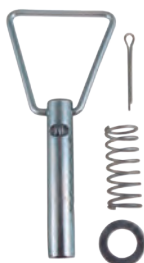

8-18400-1

MANIVELA PARA GATOS

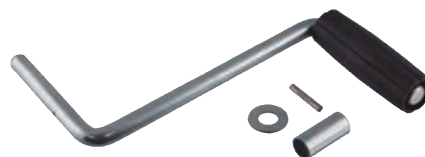

8-18918-1

MODELO	DESCRIPCIÓN
8-015500-1	Tapa para gato
8-015904-1	Aro sujetador para gato 5-151401-1 y 5-151421-1
8-018917-1	Manivela para gatos 5-151401-1 /y 5-190500-1
8-115909-1	Placa sujeción para gato 5-151401-1 y 5-151421-1
8-18400-1	Perno para gatos 5-151401-1 y 5-151421-1
8-18918-1	Manivela para gatos.

**CILINDRO DE MONTAJE PARA GATO**



**8-5006-1**

**RUEDA DESMONTABLE 1,000 LB**



**8-80552-1**

**RUEDA DESMONTABLE RAM 1,000 LB**



**8-80552Q-1**

**CILINDRO DE MONTAJE PARA GATO**



**8-82500-1**

**SOPORTE PARA GATO FIJO**



**8-82650-1**

**SOPORTE PARA GATO FIJO**



**8-82650P-1**

<b>MODELO</b>	<b>DESCRIPCIÓN</b>
8-5006-1	Cilindro de montaje para gato 5-178201-1
8-80552-1	Rueda desmontable 1,000 LB para gato
8-80552Q-1	Rueda desmontable Ram 1,000 LB para gato
8-82500-1	Cilindro de montaje para gato 5-82471-1
8-82650-1	Soporte para gato fijo 5-80401-1 / 5-80402-1 y 5-81041-1
8-82650P-1	Soporte para gato fijo 5-80401-1 / 5-80402-1 y 5-81041-1

**CILINDRO MAESTRO  
PARA TIRÓN**



8-23744-1

**PERNO DE 5/16"  
CON CADENA**



8-25201-1

**BASE "D" TIRÓN  
CUELLO DE GANSO**



8-3132HB-1

**CANAL PARA TIRÓN  
3 POSICIONES**



8-B8978-1

**BOLA DE REPUESTO  
TIRÓN 1-BPH2000-1**



1-RB2000-1

**BOLA DE REPUESTO  
TIRÓN 1-BH82516-1**



1-RB2516-1

**BOLA DE REPUESTO  
KIT BOLA OCULTA 1-G9000-1**



1-2516114HT-1

**ABRAZADERAS REPUESTO  
KIT BOLA OCULTA 1-G9000-1**



1-BRB03-1

MODELO	DESCRIPCIÓN
8-23744-1	Cilindro maestro para tirón 1-16075-1
8-25201-1	Perno de 5/16" con cadena para tirón 2B8/3B8
8-3132HB-1	Base "D" tirón cuello de ganso bola 2 5/16
8-B8978-1	Canal para tirón 90105 de 3 posiciones
1-RB2000-1	Bola de repuesto 2" para tirón 1-BPH2000-1
1-RB2516-1	Bola de repuesto 2-5/16" para tirón 1-BH82516-1
1-2516114HT-1	Bola de repuesto 2-5/16" para Kit bola oculta 1-G9000-1
1-BRB03-1	Abrazaderas de repuesto para Kit bola oculta 1-G9000-1

**ANILLO EN FORMA "D"  
5/8" CON SOPORTE**



**9-7404-1**

**ANILLO EN FORMA "D"  
1/2" CON SOPORTE**



**9-7405-1**

**ESCALÓN  
GALVANIZADO**



**9-B2797Z-1**

**ESCALÓN SENCILLO 24" ANCHO**



**9-HS1001-1**

**ESCALÓN DOBLE 24" ANCHO**



**9-HS1002-1**

**POLVERA CENTRAL  
CROMADA 2.95**



**9-CH295STD-1**

**POLVERA CENTRAL  
CROMADA 3.195**



**9-CH319STD-1**

**POLVERA CENTRAL  
CROMADA 4.250**



**9-CH425STD-1**

**CHAPA CROMADA  
CON LLAVE**



**9-L1883-1**

<b>MODELO</b>	<b>DESCRIPCIÓN</b>
9-7404-1	Anillo en forma "D" 5/8" con soporte.
9-7405-1	Anillo en forma "D" 1/2" con soporte.
9-B2797Z-1	Escalón galvanizado con base.
9-HS1001-1	Escalón sencillo 24" de ancho.
9-HS1002-1	Escalón doble 24" de ancho.
9-CH295STD-1	Polvera central cromada para Rin 12".
9-CH319STD-1	Polvera central cromada para Rin 13", 14" y 15".
9-CH425STD-1	Polvera central cromada para Rin 15" y 16" (sólo 6 birlos).
9-L1883-1	Chapa cromada con llave.

CHAPA GALVANIZADA SIN LLAVE



9-N3980-1

PERNO DE 1/4" CON ARO SUJETADOR

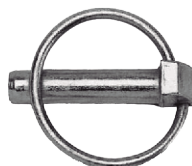

9-66000-1

PERNO DE 3/16" CON ARO SUJETADOR



9-66003-1

PERNO 1/4" X 2" CON SEGURO SUJETADOR



9-66050-1

PERNO CON CLIP "R" 1/2" X 4-1/2"

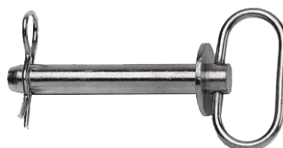

9-66100-1

PERNO CON CLIP "R" 5/8" X 6-1/4"

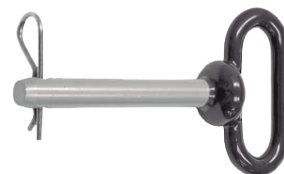

9-66105-1

BARRA DE ACERO NEGRO STD PARA TENSOR



9-1903060-60

CINCHO PARA WINCH 20' X 2" CON GANCHO



9-3650-1

SOPORTE PARA LLANTA



9-6100-1

MODELO	DESCRIPCIÓN
9-N3980-1	Chapa galvanizada sin llave
9-66000-1	Perno de 1/4" con aro sujetador
9-66003-1	Perno de 3/16" con aro sujetador
9-66050-1	Perno de 1/4" x 2" con seguro sujetador
9-66100-1	Perno de 1/2" x 4-1/2" con clip R
9-66105-1	Perno de 5/8" X 6-1/4" con clip R
9-1903060-60	Barra de acero negro estándar para tensor
9-3650-1	Cincho para winch 20' x 2" con gancho
9-6100-1	Soporte para llanta refacción, Rin 13", 14" y 15"

**SOPORTE PARA LLANTA**



9-6100A-1

**LIGADOR DE CADENA  
3/8" A 1/2"**



9-10035-60

**TENSOR DE CADENA  
5/16" A 3/8"**



9-3500-60

**TENSOR DE 2" X 12'  
PARA RIEL**



9-10120-60

**BANDA DE 2" X 16'  
PARA RIEL**



9-10160-60

**RIEL LOGÍSTICO ACERO**



9-3700-60

**BANDA USO TEC.  
POLY 4" SUJECCIÓN**



9-4004L-60

**TENSOR BANDA CON MATRACA**



9-71168145-60

**ARGOLLA DE  
ACERO P/PISO**



9-7190-60

MODELO	DESCRIPCIÓN
9-6100A-1	Soporte para llanta refacción Rin 13" y 14" tipo abrazadera
9-10035-60	Ligador de cadena 3/8" a 1/2", 9,200 LB para sujeción
9-3500-60	Ajustador de cadena 5/16" a 3/8", 5,400 LB para sujeción
9-10120-60	Tensor de 2' x 12" Mat., para riel logístico/sujeción
9-10160-60	Banda de 2" x 16' Mat y Acc., para riel/sujeción
9-3700-60	Riel logístico de acero tipo pintado de 10 pies para sujeción
9-4004L-60	Banda uso Tec, Poly 4", 24,000 LB para sujeción
9-71168145-60	Tensor con banda 1" azul con matraca 16'
9-7190-60	Argolla de acero para piso con arandela negra



**BANDA 4" CON GANCHO PLANO**



9-7420WS-60

**ENROLLADOR DE ACERO ATORNILLABLE**



9-7429P-60

**ENROLLADOR DE ACERO SOLDABLE**



9-7430P-60

**TENSOR DE ACERO CON BANDA 2"**



9-802HD27FG-60

**TENSOR DE ACERO CON BANDA 2"**



9-802HD27F-60

**BANDA POLY 2" DORADO**



9-925TY-60

**GANCHO ALAMBRE 2" 10,000 LB**



9-636-60

**BARRA ESTABILIZADORA ACER 89-105**



9-CB1085-60

<b>MODELO</b>	<b>DESCRIPCIÓN</b>
9-7420WS-60	Banda 4" con gancho plano 9 metros
9-7429P-60	Enrollador de acero atornillable para sujeción
9-7430P-60	Enrollador de acero soldable estándar para sujeción
9-802HD27F-60	Tensor de acero con banda 2" gancho plano 27'
9-802HD27FG-60	Tensor de acero con banda 2" gancho de acero
9-925TY-60	Banda Poly 2" dorado 10,000 LB para sujeción
9-636-60	Gancho de alambre 2" 10,000 LB
9-CB1085-60	Barra estabilizadora Acer 8-105 para sujeción

**CONCHA 12" RADIO\***  
5' X 37" X 15"

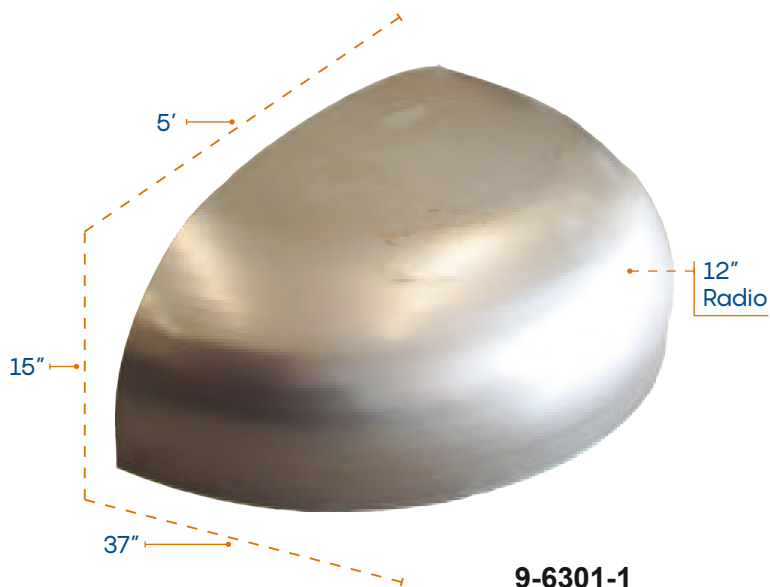

**9-6301-1**

\*También disponible en fibra de vidrio.

**CONCHA 6" RADIO\***  
6' X 37" X 8"



**9-6305-1**

\*También disponible en fibra de vidrio.

**ESQUINERO PARA REMOLQUE**

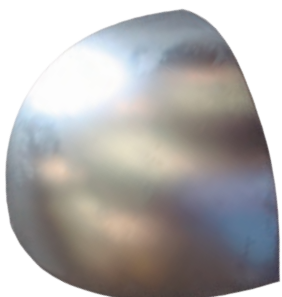

**9-6311-1**

**VENTILADOR ALUMINIO 7-1/2"**



**9-6501-1**

**BISAGRA GALVANIZADA DE 8"**



**9-B2423F-1**

MODELO	DESCRIPCIÓN
9-6301-1	Concha 12" radio, 5' x 37" x 15" lámina
9-6301F-75	Concha 12" radio, 5' x 37" x 15" fibra de vidrio
9-6305-1	Concha 6" radio, 6' x 37" x 8" lámina
9-6305F-75	Concha 6" radio, 6' x 37" x 8" fibra de vidrio
9-6311-1	Esquinero para remolque
9-6501-1	Ventilador de aluminio 7-1/2" de diámetro
9-B2423F-1	Bisagra galvanizada de 8"

**PERNO DE 1/2" CON  
RESORTE,  
AMBOS SENTIDOS**



**9-B2595-1**

**PERNO DE 1/2" CON  
RESORTE,  
AMBOS SENTIDOS**



**9-B2595-660**

\*Solicitar el sentido requerido a un Asesor Omega al momento de realizar su compra.

**SEGURO PARA PUERTA**



**9-DH500-1**

**SEGURO DE VENTANA**



**9-L207-1**

MODELO	DESCRIPCIÓN
9-B2595-1	Perno de 1/2", acero, ambos sentidos, importado.
9-B2595-660	Perno de 1/2", acero, ambos sentidos, nacional.
9-DH500-1	Seguro para puerta
9-L207-1	Seguro de ventana



## Conoce también nuestra línea de **PRODUCTOS PARA ANDENES**



Sellos  
para Andén



Restrictores  
de Movimiento



Puertas  
Seccionales



Niveladores



Puertas  
Rápidas



Sistemas de  
Volteo

Grupo Omegalfa, S de R.L. de C.V.  
Calle 3 No. 763, Zona Industrial, CP.44940  
Guadalajara, Jalisco, México.

☎ 01 (33) 3145-1765 & 3145-3714



[grupoomegalfa.com](http://grupoomegalfa.com)